

5000.1012K1M Low Profile DATA SHEET

GRATE OPTIONS

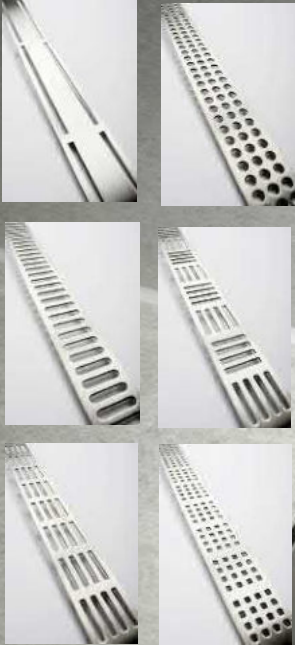

KIT CONTAINS

UNIDRAIN GLASSLINE UNIT WITH
INTEGRATED GLASS CHANNEL
LOW PROFILE OUTLET
CLASSICLINE FRAME
ANNIVERSARIO GRATE
GLASS SCREEN

5002.1012 | 5003.1012 Glassline Module

For right-aligned shower screen

For left-aligned shower screen



ITEM NUMBER R

5002.1012

ITEM NUMBER L

5003.1012

Specifications

MATERIAL	SURFACE	FLOORING
1,5 mm stainless steel (AISI 304)	Pickled	Tiles
MEMBRANE	FLOOR CONSTRUCTION	INSTALLATION WIDTH (A)
Liquid or sheet membrane	Concrete/wood	1001 mm
INSTALLATION DEPTH (B)	CENTRE (C)	SHOWER SCREEN SIZE (D)
1301 mm	501 mm	1200 mm

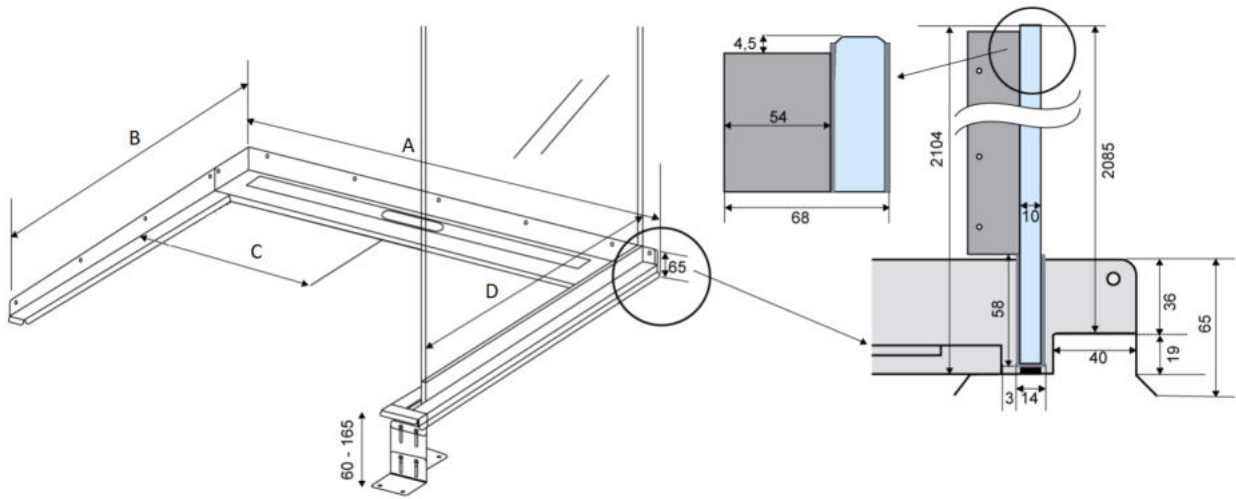

1417.0050 - Low Profile Outlet

Linear 1417.0050

Ø 50 mm horizontal drain

The odour barrier can be removed for cleaning

Can be rotated 180 degrees if a rear-facing outlet is required

Note: Odour barrier is VA-approved



Specifications

ITEM NUMBER	GTIN NUMBER	WEIGHT INCLUDING PACKAGING
1417.0050	5707692007915	500 g
WEIGHT EXCLUDING PACKAGING	MATERIAL	USAGE
350 g	Plastic (PP)	Line drain
BARRIER	GASKET	CAPACITY
With (odour barrier)	EPDM	0.6 l/s
SIDE INLET	CENTER	FITS DRAIN UNIT
Without	30 mm	1001, 1002, 1003, 1004, 1100, 3002, 3004, 5002, 5003, 4004

FITTING HEIGHTS - LINE FAUCETS 1001, 1002, 1003, 1004

Ø	Outlet direction	300	600	700	800	900	1000	1200
Ø 50 mm	Horizontal	64 mm	68 mm	69 mm	70 mm	71 mm	72 mm	74 mm

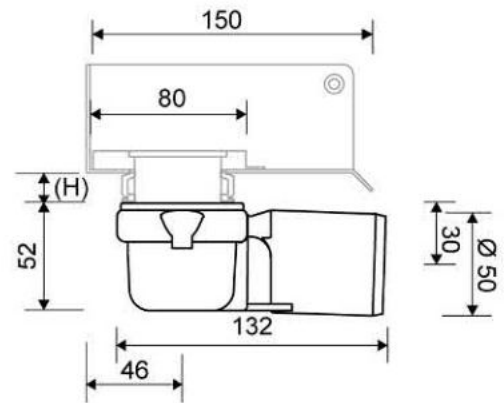
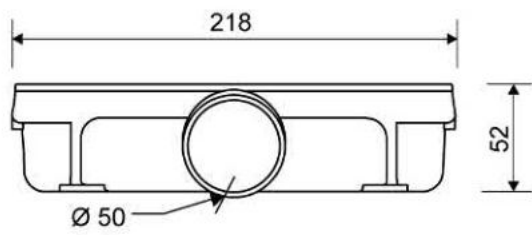
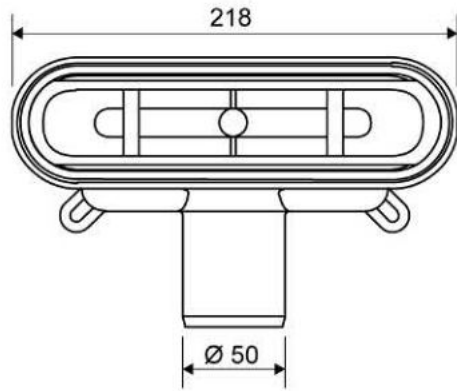

1500.1012

Line 1500

Available in 8, 10 and 12 mm heights (depending on the thickness of the floor tile)



Specifications

ITEM NUMBER	GTIN NUMBER	WEIGHT INCLUDING PACKAGING
1500.1012	5707692003382	1250 g
WEIGHT EXCLUDING PACKAGING	MATERIAL	USAGE
1020 g	Stainless steel (AISI 304)	Line drain
SURFACE	INSTALLATION LENGTH (L)	HEIGHT (H)
Brushed	995 mm	H 12 mm
LENGTH MODEL	FITS DRAIN UNIT	INSERT
1000 mm	1001, 1002, 1003, 1004, 1100, 5002, 5003	Synthetic

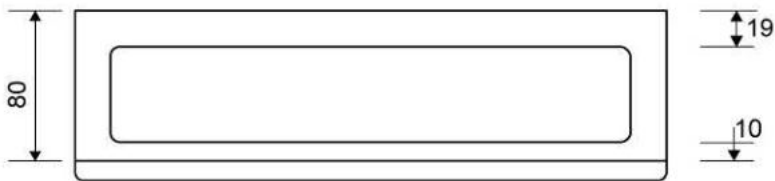
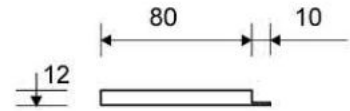
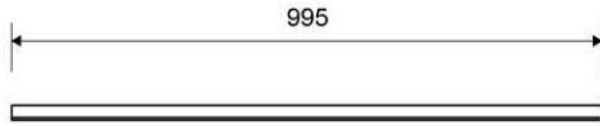

1500.1012

1606.1000 - 1000mm Anniversario Grate

Line 1600

Brushed Stainless Steel grate to be placed onto Classicline Frame

Contact Wet Room Materials for other grate options

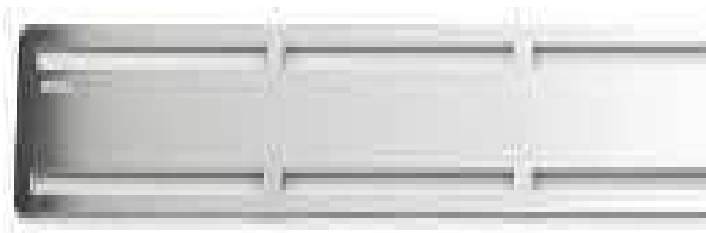

Other grates available

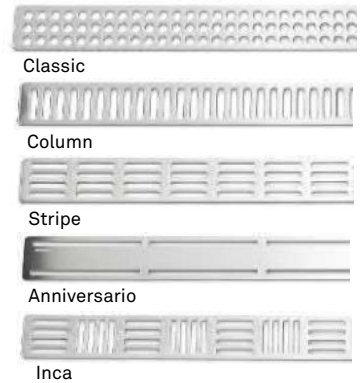

Specifications

ITEM NUMBER	GTIN NUMBER	WEIGHT INCLUDING PACKAGING
1604.1000	5707692001203	940 g
WEIGHT EXCLUDING PACKAGING	MATERIAL	USAGE
910 g	Stainless steel (AISI 304)	Line drain
SURFACE	LENGTH MODEL	DIMENSIONS
Brushed	1000 mm	3 mm solid3 mm solid3 mm solid3 mm solid3 mm solid3 mm solid

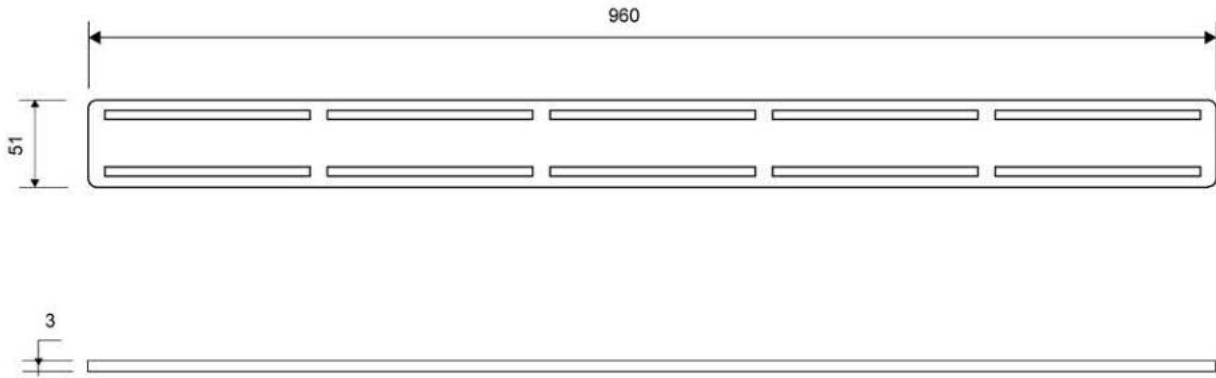

1606.1000

Products

5100.1200

GlassLine | Right and left-aligned shower screen

Design: Transparent

10 mm safety glass

No visible screws or fittings in the finished result

The glass surface is treated with Cleantec nanotechnology, making it water-repellent, less susceptible to limescale and easier to clean.



Specifications

ITEM NUMBER	LENGTH MODEL	HEIGHT (H)
5100.1200	1200 mm	2104 mm
DESIGN	MATERIAL	
Transparent	Stainless steel (AISI 304) 10 mm safety float glass	

